



Cambridge IGCSE™

DESIGN AND TECHNOLOGY

0445/43

Paper 4 Systems and Control

May/June 2022

MARK SCHEME

Maximum Mark: 50

Published

This mark scheme is published as an aid to teachers and candidates, to indicate the requirements of the examination. It shows the basis on which Examiners were instructed to award marks. It does not indicate the details of the discussions that took place at an Examiners' meeting before marking began, which would have considered the acceptability of alternative answers.

Mark schemes should be read in conjunction with the question paper and the Principal Examiner Report for Teachers.

Cambridge International will not enter into discussions about these mark schemes.

Cambridge International is publishing the mark schemes for the May/June 2022 series for most Cambridge IGCSE, Cambridge International A and AS Level and Cambridge Pre-U components, and some Cambridge O Level components.

This document consists of **14** printed pages.

Generic Marking Principles

These general marking principles must be applied by all examiners when marking candidate answers. They should be applied alongside the specific content of the mark scheme or generic level descriptors for a question. Each question paper and mark scheme will also comply with these marking principles.

GENERIC MARKING PRINCIPLE 1:

Marks must be awarded in line with:

- the specific content of the mark scheme or the generic level descriptors for the question
- the specific skills defined in the mark scheme or in the generic level descriptors for the question
- the standard of response required by a candidate as exemplified by the standardisation scripts.

GENERIC MARKING PRINCIPLE 2:

Marks awarded are always **whole marks** (not half marks, or other fractions).

GENERIC MARKING PRINCIPLE 3:

Marks must be awarded **positively**:

- marks are awarded for correct/valid answers, as defined in the mark scheme. However, credit is given for valid answers which go beyond the scope of the syllabus and mark scheme, referring to your Team Leader as appropriate
- marks are awarded when candidates clearly demonstrate what they know and can do
- marks are not deducted for errors
- marks are not deducted for omissions
- answers should only be judged on the quality of spelling, punctuation and grammar when these features are specifically assessed by the question as indicated by the mark scheme. The meaning, however, should be unambiguous.

GENERIC MARKING PRINCIPLE 4:

Rules must be applied consistently, e.g. in situations where candidates have not followed instructions or in the application of generic level descriptors.

GENERIC MARKING PRINCIPLE 5:

Marks should be awarded using the full range of marks defined in the mark scheme for the question (however; the use of the full mark range may be limited according to the quality of the candidate responses seen).

GENERIC MARKING PRINCIPLE 6:

Marks awarded are based solely on the requirements as defined in the mark scheme. Marks should not be awarded with grade thresholds or grade descriptors in mind.

Question	Answer	Marks	Guidance
Section A			
1	Frame structure, 1 mark. Shell structure, 1 mark. Mass structure, 1 mark.	3	Allow examples of the types of structure Any examples must only be applicable to a single type of structure.

Question	Answer	Marks	Guidance
2(a)	<p>Methods visible are:</p> <ul style="list-style-type: none"> • Heavy section timber • Cross braces • Triangulation • Solid foundations • Increased width at base • Bolts are used to join sections of timber. <p style="text-align: right;">2 × 1 marks.</p>	2	<p>Allow any other valid response.</p> <p>Description that includes two points, 2 marks.</p> <p>Allow 2 marks for single fully justified point.</p>
2(b)	<p>Reasons for choosing wood will include:</p> <ul style="list-style-type: none"> • Local availability of timber • Available in large section • Slightly flexible compared to other materials • Easily repaired / maintained • Durable • Renewable resource • Resists forces well e.g. compression / tension / torsion • Easily joined, nails, screws, bolts, mechanical joints. <p style="text-align: right;">2 × 1 marks.</p>	2	<p>AOVR</p> <p>Do not allow 'cheap' or 'low cost' unless it is justified.</p>

Question	Answer	Marks	Guidance
3(a)	Advantages of plastics for window frames include: <ul style="list-style-type: none"> • Better weather resisting properties • Better insulation • Reduces maintenance • Plastic can be extruded / moulded to a shape • Long lasting / durable • Lighter weight to handle when fitting • Dimensionally more stable. <p style="text-align: right;">2 × 1 marks.</p>	2	Allow any other valid response. Only allow 'Cost' if justified.
3(b)	Disadvantages of plastics include: <ul style="list-style-type: none"> • Reduced aesthetic qualities • Can discolour when exposed to UV from sun • Can become brittle. • Environmentally unsound • Not as resistant to compression. <p style="text-align: right;">2 × 1 marks.</p>	2	Allow any other valid response. Do not allow cost of materials.

Question	Answer	Marks	Guidance
4	Oil is used in a car engine to: <ul style="list-style-type: none"> • Lubricate the moving parts • Reduce friction • Prevent metal to metal contact • Remove grit / metal fragments from the moving parts • Assist with cooling of the engine. <p style="text-align: right;">2 × 1 marks.</p>	2	Allow 'reduces / prevents' corrosion.

Question	Answer	Marks	Guidance
5	<p>1 mark for each correct label, 4 × 1 marks.</p>	4	

Question	Answer	Marks	Guidance
6	Symbol A – motor Symbol B – NPN transistor Symbol C – ammeter 3 × 1 marks	3	Accept 'transistor' or 'bipolar junction transistor (BJT)'.

Question	Answer	Marks	Guidance
7	PTM switches have contacts that close when the switch is pressed. PTB switches have contacts that open when the switch is pressed.	2	1 mark for each point in the explanation. Max 1 mark for expansion to full words.

Question	Answer	Marks	Guidance
8	Accept any named metal. E.g. copper, gold, silver, aluminium.	1	

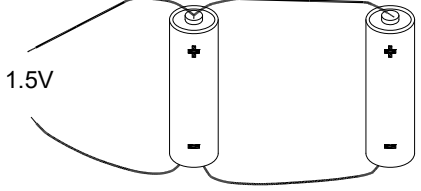
Question	Answer	Marks	Guidance
9	 <p>Batteries connected in parallel, 1 mark. Correct polarity, 1 mark.</p>	2	No mark for any series connections.

Question	Answer	Marks	Guidance																				
Section B																							
10(a)(i)	Lamination is the method of construction	1																					
10(a)(ii)	Properties of adhesive could include: <ul style="list-style-type: none"> • Must be waterproof / water resistant • Gap filling • Resistant to movement of the wood • High tensile strength • Resistant to shear. 	2	Description that includes two points, 2 marks. Allow 2 marks for single fully justified point.																				
10(a)(iii)	Benefits of laminating will include: <ul style="list-style-type: none"> • Large stable section of wood is produced • Increased resistance to bending • Improved precision • Natural defects can be avoided • Consistent results in a batch. <div style="text-align: right;">2 × 1 marks</div>	2	Allow other valid benefits. Do not allow cheap, easy.																				
10(b)(i)	<table border="1" style="width: 100%; border-collapse: collapse; text-align: center;"> <thead> <tr> <th>Method</th> <th>Bending</th> <th>Torsion</th> <th>Compression</th> <th>Tension</th> </tr> </thead> <tbody> <tr> <td>W</td> <td>✓</td> <td></td> <td>✓</td> <td></td> </tr> <tr> <td>X</td> <td></td> <td>✓</td> <td></td> <td>✓</td> </tr> <tr> <td>Y</td> <td>✓</td> <td>✓</td> <td></td> <td></td> </tr> </tbody> </table> 6 × 1 marks	Method	Bending	Torsion	Compression	Tension	W	✓		✓		X		✓		✓	Y	✓	✓			6	For Y allow compression. No mark for a row with more than two ticks.
Method	Bending	Torsion	Compression	Tension																			
W	✓		✓																				
X		✓		✓																			
Y	✓	✓																					
10(b)(ii)	Improvement identified in notes / sketches, 1 mark Force being resisted clearly identified, 1 mark Functional method, 1 mark.	3																					

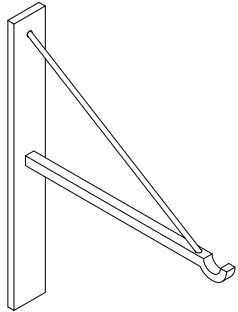
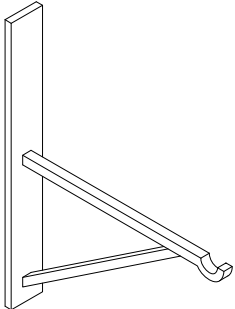
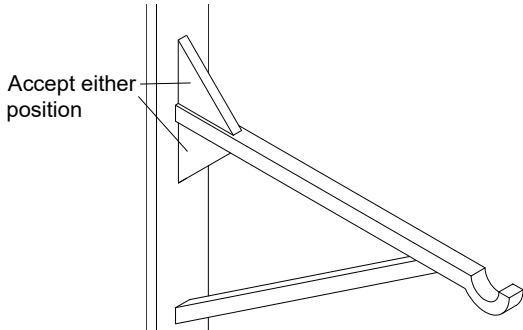
Question	Answer	Marks	Guidance
10(c)(i)	 <p data-bbox="338 576 1312 611">Tie in suitable position, 1 mark. Suitable section of material shown, 1 mark.</p>	2	
10(c)(ii)	 <p data-bbox="338 965 898 1031">Strut in suitable position, 1 mark. Suitable section of material shown, 1 mark.</p>	2	
10(c)(iii)	 <p data-bbox="338 1406 1088 1437">Suitable shape of plate, 1 mark. Suitable position, 1 mark.</p>	2	

Question	Answer	Marks	Guidance
10(d)(i)	The limit stop is used to support the barrier in the down position, 1 mark. To avoid any strain on the motor, 1 mark.	2	Accept any other valid response.
10(d)(ii)	$3 \times X = 0.8 \times 245$, 1 mark $X = 196 / 3$, 1 mark $X = \mathbf{65.3\ N}$, 1 mark.	3	Award 3 marks for answer with no working.

Question	Answer	Marks	Guidance
11(a)(i)	Stainless steel properties - hygienic, will not rust or corrode, long lasting. Nylon – self-lubricating bearing / gear material, can be easily moulded, durable. 2 x 1 marks.	2	Allow 'durable' for stainless steel.
11(a)(ii)	The mechanism in the turning handle is a crank .	1	
11(a)(iii)	Velocity ratio = $60 / 12 [1] = \mathbf{5:1[1]}$ Numerical answer, 1 mark. Given as a ratio, 1 mark.	2	5:1 2 marks 1:5 no mark unless the working is correct.
11(a)(iv)	Speed of beaters = 30×5 , 1 mark = 150 rpm 1 mark.	2	Award 2 marks for correct answer with no working. Allow ecf from (ii)
11(a)(v)	Each beater will turn at the same speed as the other one, 1 mark They will turn in opposite directions , 1 mark.	2	
11(b)(i)	Types of bearings include, plain, ball, roller , 1 mark for each.	3	Accept ceramic, needle or self-aligning bearings.

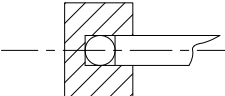
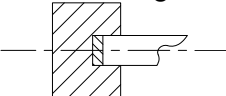
Question	Answer	Marks	Guidance
11(b)(ii)	<p>The purpose if a bearing is to:</p> <ul style="list-style-type: none"> • Provide support to a moving part of a mechanism. • Reduce friction between moving parts • Reduce wear in the mechanism parts • Support both radial and axial loads. • Reduce contact area. 	2	<p>Allow other relevant points.</p> <p>Description that includes two points, 2 marks.</p> <p>Allow 2 marks for single fully justified point.</p>
11(b)(iii)	<div style="display: flex; justify-content: space-around; align-items: center;"> <div style="text-align: center;"> <p>ball bearing</p>  </div> <div style="text-align: center;"> <p>plain bearing</p>  </div> </div> <p>Shaft shown or described in suitable position, 1 mark. Recognised type of thrust bearing used, ball, roller, plain, 1 mark Functional method used, 1 mark.</p>	3	
11(c)(i)	<p>Description to use relative positions of fulcrum, load and effort.</p> <ul style="list-style-type: none"> • First Order is E F L with fulcrum in the centre. • Second order is E L F with load in the centre • Third order is effort in the centre, F E L <p>1 mark for each correct statement. 3 × 1 marks</p>	3	
11(c)(ii)	<p>Reasons for importance of levers in hand operated machinery will include:</p> <ul style="list-style-type: none"> • To make operation of the machine easier, requiring less effort. • To provide a mechanical advantage • To reduce fatigue in workers • To make operation of the machine safer. • To allow more precise control • Gives feedback to user. <p style="text-align: right;">2 × 1 marks</p>	2	<p>Explanation with two points, 2 marks. Allow 2 marks for single fully justified point.</p>
11(d)(i)	The mechanical advantage is 8 .	1	
11(d)(ii)	<p>Effort needed to raise a mass of 200 kg is: 200 / 8, = 25 kg, 1 mark 25 kg = 25 × 9.81 = 245.25 N, 1 mark.</p>	2	<p>Allow ecf from (d)(i).</p> <p>Award 2 marks for answer with no working.</p>

Question	Answer	Marks	Guidance
12(a)(i)	R2 is a 'pull up' resistor and is used to ensure that there is always a valid output signal, either +9 V or 0 V.	1	Award mark for understanding shown.
12(a)(ii)	Advantages of a transistor switch are: <ul style="list-style-type: none"> • Speed of switching, it is a lot faster than a mechanical switch • No moving parts so will last longer • Lower cost • No contact bounce • Operated automatically, no human intervention • Smaller. <p style="text-align: right;">2 x 1 marks.</p>	2	
12(a)(iii)	Disadvantages of a transistor switch include: <ul style="list-style-type: none"> • Cannot carry as high a current as a mechanical switch • Cannot be changed directly by hand • Needs an indicator to show the state of the switch. 	1	
12(b)(i)	VR1 and R1 in series will only allow a very small current to pass through L1, 1 mark. The transistor amplifies the small current, 1 mark. L2 is connected to 0 V through the collector / emitter which allows a larger current allowing L2 to light, 1 mark.	3	Award marks for understanding shown.
12(b)(ii)	Base current = $6 / 19 \text{ k}\Omega = 0.000316 \text{ A}$, 1 mark. $48 \text{ mA} / 0.316 = \mathbf{152}$, 1 mark.	2	Allow rounding errors. Award 2 marks for a correct answer with no working.
12(b)(iii)	R1 is included to prevent damage to the transistor in the event of VR1 being set to 0Ω .	1	Allow 'protective resistor'.
12(c)(i)	Methods of identifying the cathode on a standard LED include: <ul style="list-style-type: none"> • Flat on the case • Shorter leg on the cathode • Use of a multimeter. 	2	Sketches / notes indicating one of the methods, 1 mark. Clear indication of which leg has been identified, 1 mark.

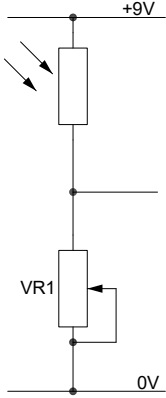
Question	Answer	Marks	Guidance
12(c)(ii)	The legs on an integrated circuit (IC) can be identified by a notch at the pin 1 end or dot next to pin 1, 1 mark Pins are numbered anticlockwise from pin 1, 1 mark.	2	
12(c)(iii)	Polarised components include: <ul style="list-style-type: none"> • Electrolytic or tantalum capacitor • Diode • Transistor • Battery / power supply. 1 mark for each correct	3	Allow voltage regulator or buzzer. Allow ammeter, voltmeter.
12(d)	 <ul style="list-style-type: none"> • Potential divider arrangement, 1 mark • Variable resistor used to provide a set level of output, 1 mark • LDR at the top of the divider, 1 mark. 	3	

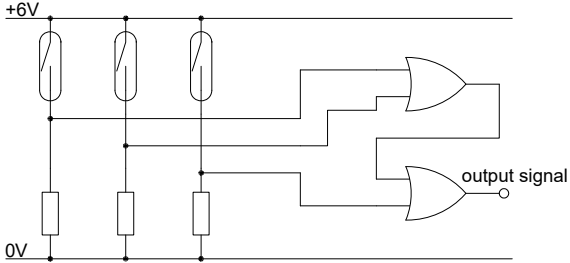
Question	Answer	Marks	Guidance
12(e)(i)		2	<p>Switches 1 and 2 to top OR gate, 1 mark.</p> <p>Output of gate 1 and switch 3 to gate 2 input, 1 mark.</p>
12(e)(ii)	<p>Explanation to include:</p> <ul style="list-style-type: none"> • Low current output from logic gate is amplified by TR1 • TR1 provides signal to activate the coil of RLA1 and both of the DT switches are closed • The top switch operates an alarm bell, the bottom switch provides an additional 0 V connection to the coil • When logic gate signal is no longer there, the coil remains activated • To reset the latch PTB switch SW1 is used. 	3	<p>3 marks for any three points</p> <p>2 marks for 2 points</p> <p>1 mark for a single valid point included.</p>